



Cordless endodontic treatment motorized handpiece

Tri Auto mini

(TR-CM)

Operation Instructions

Contents

Warnings and Prohibition	5
Features	6
Parts Identification and Accessories	7
Usage	8
(1) Before Use	8
Charge Battery.....	8
Connect Contra Angle.....	9
File Installation.....	10
Check Operation.....	11
(2) Operation	12
Basic Operation	12
Memory Settings.....	13
Memory Settings: Primary Functions.....	13
Memory Settings: Additional Operation Settings	14
Memory Settings: Other Settings.....	15
Restore Default Memories	16
(3) After Use	16
Take Out File.....	16
Usage; Operation with the Root ZX mini	17
Install File Electrode	17
Connect the Transmission Cable.....	19
Check Operation.....	19
Meter Display.....	20
Operation	20
File Electrode Replacement.....	22

Sterilization, Replacement Parts, and Storage	23
(1) Sterilization.....	23
(2) Replacement Parts.....	25
Battery Replacement	25
File Electrode Replacement.....	25
(3) Storage.....	26
Maintenance and Inspection	27
Troubleshooting	29
Technical Description	31
Appendix- Electromagnetic declaration.....	33
Safety and Accident Prevention for the Operation of Electrical Medical Devices	36

Thank you for purchasing the Tri Auto mini.

For optimum safety and performance, read this manual thoroughly before using the unit and pay close attention to warnings and notes. Keep this manual in a readily accessible place for quick and easy reference.

NOTICE TO PROTECT INTELLECTUAL PROPERTY			
US PAT.	5897315	JP PAT.	3113096
US PAT.	5902105	JP PAT.	3129888
US PAT.	5980248	JP PAT.	3223042
US PAT.	6929476	JP PAT.	3213480
US DESIGN APPLN.	29/347684	JP PAT.	3264607
DE PAT.	19520765	JP PAT.	3213539
DE PAT.	19549662	JP PAT.	3676753
DE PAT.	19702370	JP PAT.	4139809
DE PAT. APPLN.	19628854	JP PAT. APPLN.	2009-296456
DE PAT. APPLN.	19655338	JP PAT. APPLN.	2010-058711
DE PAT. APPLN.	10219648	JP DESIGN.	1394778
EP DESIGN APPLN.	1690298	JP DESIGN.	1394779
CN DESIGN APPLN.	201030166890.6		

Prevent Accidents

Attention Customers

Do not fail to receive clear instructions concerning the various ways to use this equipment as described in this accompanying Operator's Manual.

Fill out and sign the warranty and give the dealer from whom you purchased the equipment his copy.

Attention Dealers

Do not fail to give clear instructions concerning the various ways to use this equipment as described in this accompanying operator's manual.

After instructing the customer in the operation of the equipment, have him fill out and sign the warranty. Then fill in your own section of the warranty and give the customer his copy. Do not fail to send the manufacturer's copy to J. MORITA MFG. CORP.

Prevent Accidents

Most operation and maintenance problems result from insufficient attention being paid to basic safety precautions and not being able to foresee the possibilities of accidents. Problems and accidents are best avoided by foreseeing the possibility of danger and operating the unit in accordance with the manufacturer's recommendations. First thoroughly read all precautions and instructions pertaining to safety and accident prevention; then, operate the equipment with the utmost caution to prevent either damaging the equipment itself or causing bodily injury.



The following symbols and expressions indicate the degree of danger and harm that could result from ignoring the instructions they accompany:

WARNING

This warns the user of the possibility of extremely serious injury or complete destruction of the equipment as well as other property damage including the possibility of fire.

NOTE

This warns the user of the possibility of mild injury or damage to the equipment.

* The warning symbols () and note symbols () that appear next to the main text on the right hand side of the page refer to and are explained by the Warnings and Notes at the bottom of the page.

(Usage Note)

This alerts the user of important points concerning operation or the risk of equipment damage.

The user (e.g. the hospital, clinic etc.) is the party responsible for the maintenance and proper operation of a medical device.

This equipment must only be used by dentists and other legally licensed professionals.

Do not use this equipment for anything other than its specified dental purpose.

Federal law restricts this device to sale by or on the order of a dentist (for U.S.A.).

Disclaimer

- J. MORITA MFG. CORP. will not be responsible for accidents, equipment damage, or bodily injury resulting from:
 1. repairs made by personnel not authorized by J. MORITA MFG. CORP.
 2. any changes, modifications, or alterations of its products
 3. the use of products or equipment made by other manufacturers, except for those procured by J. MORITA MFG. CORP.
 4. maintenance or repairs using parts or components other than those specified by J. MORITA MFG. CORP. and other than in their original condition
 5. operating the equipment in ways other than the operating procedures described in this manual or resulting from the safety precautions and warnings in this manual not being observed
 6. workplace conditions and environment or installation conditions which do not conform to those stated in this manual such as improper electrical power supply
 7. fires, earthquakes, floods, lightning, natural disasters, or acts of God.
- J. MORITA MFG. CORP. will supply replacement parts and be able to repair the product for a period of 10 years after the manufacture of the product has been discontinued.

Warnings and Prohibition

⚠ WARNING

- This unit must not be connected to or used in combination with any other apparatus or system. It must not be used as an integral component of any other apparatus or system.
J. MORITA MFG. CORP. will not be responsible for accidents, equipment damage, bodily injury or any other trouble which results from ignoring this prohibition.
- A rubber dam should be used when performing endodontic treatment.
- No modification of this equipment is allowed.

PROHIBITION

:This indicates when not to use the equipment.

- Electromagnetic wave interference could cause this unit to operate in an abnormal, random and possibly dangerous manner. Cellular phone, transceivers, remote controls and all other devices which transmit electromagnetic waves located inside the building should be turned off.
- Instruments which produce considerable electrical noise such as electric scalpels can cause the Tri Auto mini to operate abnormally. Turn the Tri Auto mini off before using any instruments that produce electrical noise.
- Do not use this instrument on patients who have a pacemaker or an Implantable Cardioverter Defibrillator (ICD). It could cause the pacemaker or the Implantable Cardioverter Defibrillator (ICD) to function abnormally.
- Illumination devices such as fluorescent lights and film viewers which use an inverter can cause the Tri Auto mini to operate erratically. Do not use the Tri Auto mini near lights such as these.
- This unit must not be connected to or used in combination with any other apparatus or system. It must not be used as an integral component of any other apparatus or system. J. MORITA MFG. CORP. will not be responsible for accidents, equipment damage, bodily injury or any other trouble which results from ignoring the above prohibitions.
- Do not use this unit in the medical operation room.
- Blocked canals cannot be accurately measured.

* J. MORITA MFG. CORP. is not responsible for any accidents or other types of trouble that are caused by not following the prohibitions and other conditions noted above.

Features

Features and intended use:

The Tri Auto mini is a compact, cordless endodontic treatment motorized handpiece for preparation and enlargement of root canals. It may be connected to the Root ZX mini, an apex locator (sold separately).

Instructions for how to use the Tri Auto mini when it is connected to the Root ZX mini are printed on a blue background like this one.

■ Liquid Crystal Display (LCD) :

The LCD is easy to read and shows all settings as well as how the motor is running.

■ Controls :

- Speed :** Eleven rotation speeds can be set from 50 to 1,000 rpm.
- Torque Reverse :** The motor automatically reverses its rotation if the torque load exceeds the set value to reduce the risk of jamming.
- Slow Down :** The file slows down as torque increases.
The file slows down as it approaches the apex if the Tri Auto mini is connected to the Root ZX mini.
- Forward & Reverse :** The file may rotate in both forward and reverse directions.
- Auto Start & Stop* :** The file starts when it is inserted in the canal and stops when it is taken out.
- Apical Reverse or Stop* :** The motor reverses or stops when the tip of the file reaches a preset position inside the canal.
- Apical Torque Reduction* :** The automatic torque reverse value is reduced as the file tip approaches the apex.

* These controls can be used if the Tri Auto mini is connected to the Root ZX mini.

■ Memory:

Six combinations of speed, torque etc. can be memorized.

Parts Identification and Accessories

Parts Identification



Accessories

Battery
*Inside motor handpiece



Power Supply Cord



AR Oil



Handpiece Rest
(Option)

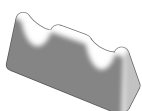

Transmission Cable
(Option)



File Electrode
(Option)



Usage

■ Operation Conditions for the main unit and AC adapter

Temperature: 10 to 40°C (50 to 104°F), Relative Humidity: 30 to 75 %RH (without condensation), Atmospheric Pressure : 700 to 1,060hPa

* If the unit has not been used for some time, make sure it works properly before using it again.

(1) Before Use

Charge Battery

The battery is built into the motor handpiece.

* Ambient (room) temperature for charging is from 10°C (50°F) to 40°C (104°F).

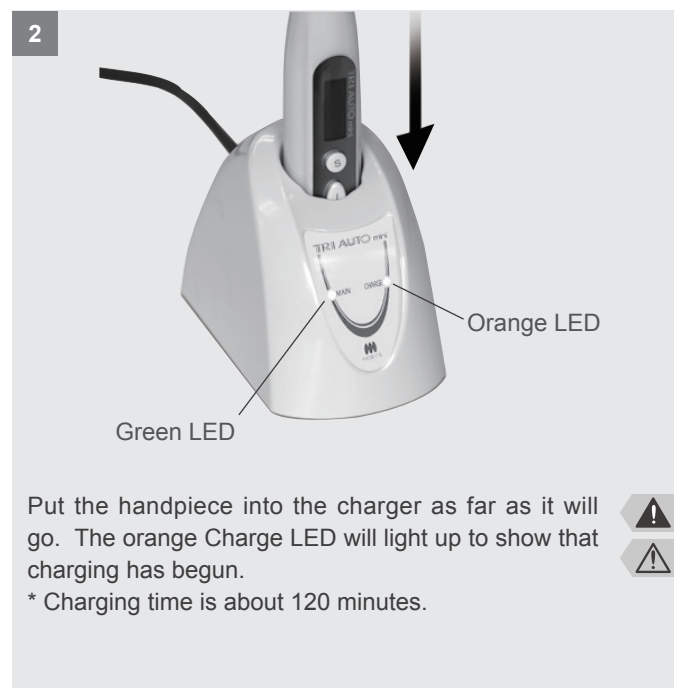
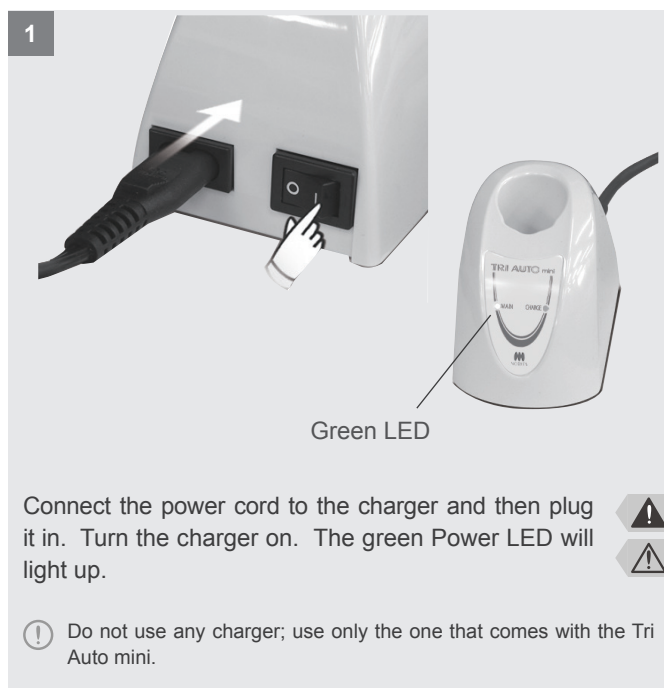

- ⓘ Charge the battery as soon as the battery power indicator gets down to its last bar.
- ⓘ If the orange charge LED goes off immediately or doesn't light up when the handpiece is put into the charger, the battery is probably fully charged. To make sure, take the handpiece out and put it back in again.
- ⓘ Make sure the contact areas for the handpiece and charger are free of debris, especially metal fragments. Wipe with ethanol to remove any foreign debris. Do not press down too hard to wipe the charging areas; this could bend the electrical contacts.
- ⓘ Do not leave the charger where it will be exposed to direct sunlight.

⚠️ WARNING

- If an electrical storm occurs while the battery is being charged, do not touch the charger or its cord as there would be a risk receiving an electric shock.
- Do not get the charger wet or use it where it might get wet.

⚠️ NOTE

- The battery is not charged when the unit is shipped from the factory and must be charged before using the unit.
- Do not pull or yank the cord when disconnecting the AC adapter. Always grip the connectors.
- Use only the power cord provided and plug both ends all the way in.
- Charger and power supply cord must be located outside the so called patient environment (2.0 m around the patient location).

Charge Battery



The number of bars shows how much battery power is left. Recharge the battery when there is only one bar left.



If the battery runs almost completely out, the Tri Auto mini will automatically turn itself off after about 10 seconds. Recharge the battery as soon as possible.



If the battery power is very low and a large load is applied to the file, the motor may stop or the unit may turn itself off.

This is for safety; there may not be enough power to run the motor with sufficient stability. Recharge the battery if the display shown to the left appears frequently.

Connect Contra Angle

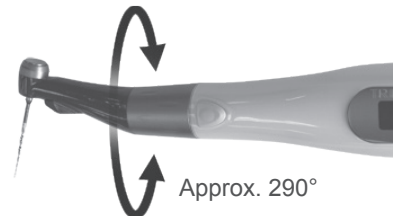
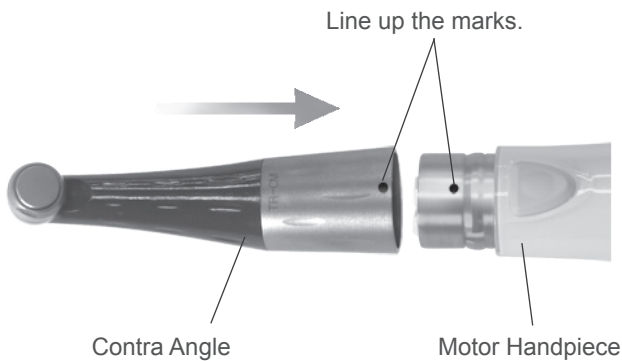

The rotation range of the contra angle is about 290°. Set it so that it reaches the treatment area and the display is easy to see.

⚠ Do not force the contra angle to rotate beyond its limit.

Line up the match marks and push the contra angle onto the handpiece until there is an audible click.

* The contra angle must be lubricated with AR Oil before using for the first time. Refer to "Lubricate the Contra Angle with AR Oil".



⚠ WARNING

- Make sure the connection components for both the handpiece and the contra angle are not damaged. An improper connection could cause the motor to reverse unexpectedly and result in injuring the patient.

⚠ NOTE

- Push the contra angle all the way onto the handpiece and then give it a light tug to make sure it is securely attached.

File Installation

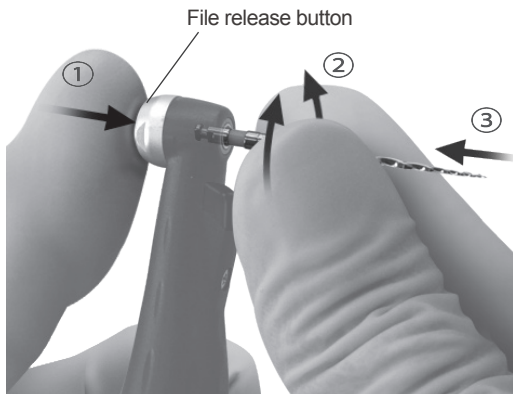

Hold down the file release button
Insert the file and turn it back and forth until it lines up
with the latch mechanism.
Push the file all the way into the latch. Release the file
release button.



ⓘ Use either Nickel-titanium or stainless steel files.

For use with the Root ZX mini, connect the file electrode
and the transmission cable .

⚠ WARNING

- Never use deformed or damaged files.
- Give the file a light tug to confirm it is securely held in place. If the file is not securely placed, it could come out and injure the patient.

⚠ NOTE

- Use caution when inserting and removing files to avoid injury to fingers.
- Inserting and removing files without holding the file release button down will damage the chuck.
- Make sure the Tri Auto mini is turned off before inserting or removing files.
- Do not connect the file electrode if the handpiece is not connected to the Root ZX mini.

Check Operation

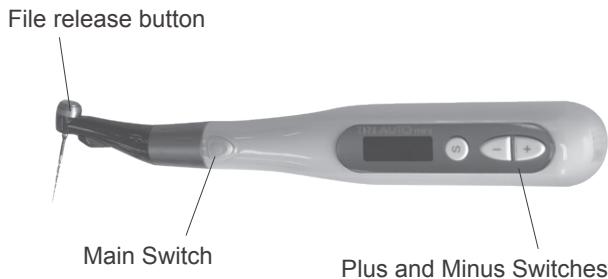

Error: 00
Chk - 0M

If a malfunction occurs, the Tri Auto mini will stop working. In this case, contact your local dealer or J. MORITA CORP. The number that appears after Error will depend on the type of malfunction.

- Make sure the contra angle and handpiece are properly and securely connected.
- Make sure the file is securely installed; give it a light tug.
- Check switch operation.



Turn the Main switch on and use the Plus or Minus switches to select a memory. Then press the main switch again to see if the Tri Auto mini runs smoothly.

Refer to page 11 for instructions on checking the Tri Auto mini's operation when it is connected to the Root ZX mini.

⚠ WARNING

- Operate the Tri Auto mini outside the oral cavity to make sure it will operate properly before using it for treatment.
- Some canals may be impossible to enlarge; always take an X-ray to check.
- Nickel-titanium file may suddenly snap depending on the curvature and shape of the canal; stop using the file if you notice or feel anything amiss.
- Files will eventually break due to metal fatigue and should be replaced before they reach this point.
- Electric noise or a malfunction could interfere with the motor control. Do not depend entirely on the unit controlling itself; always watch the display and be aware of tactile feedback.
- Files will jam and break if too much force is applied to them.
- Files may break even when the torque reverse is turned on, depending on the setting value. Never exert excessive force on the file.
- Files designed for use with engines break easily if too much force is applied. Also do not use these files for canals with excessive curvature.
- Always examine files for stretching and other deformities or damage before using them. Any type of deformity could result in the file breaking.
- Do not let the file release button on the contra angle press against the teeth opposite to the treatment area; this could cause the file to come out and result in an injury.
- Do not press the file release button while the motor is running. It could heat up and cause a burn, or the file could come out and cause an injury.

⚠ NOTE

- Stop using the Tri Auto mini if you feel or notice anything unusual. The Tri Auto mini cannot be used for every canal and should be used along with manual enlargement.
- File break more easily at fast speeds; always follow the file manufacturer's usage recommendations. Also always check the speed settings before use.
- Do not use any type of files except nickel-titanium and stainless steel ones.
- Nickel-Titanium files are easily broken; note the following points.
 - Open the canal up to the apical constriction manually before using a nickel-titanium file.
 - Never use excessive force to insert the file.
 - First remove all foreign matter, such as bits of cotton from the root canal.
 - Never use excessive force to advance the file down the root canal.
 - Do not use for extremely curved canals.
 - Try not to trigger the auto torque reverse function when advancing the file down the canal.
 - Do not skip file sizes; suddenly using a much larger file could break it.
 - If you encounter resistance or the auto torque reverse is triggered, back the file up 3 or 4 mm and carefully advance it down the root canal again. Or replace the file with a smaller size. Never use excessive force.
 - Do not force the file down the root canal or press it against the root canal wall.
 - Do not use the same file continuously in one position as this may create "steps" on the root canal wall.
- Always take file out of the contra angle after use.

(2) Operation

Basic Operation

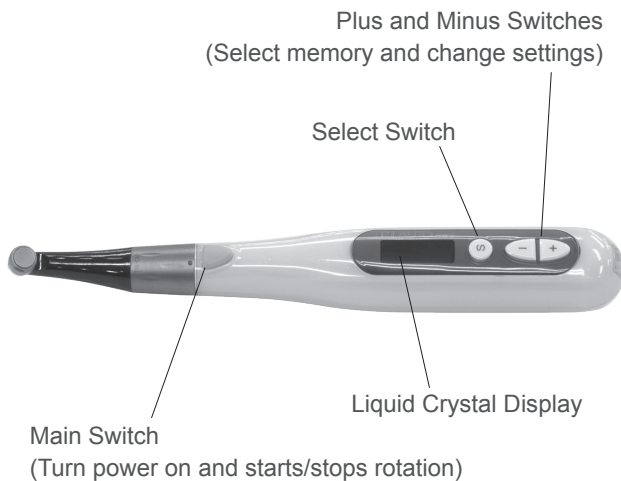

Standby Display



- ① Memory Number
- ② Rotation Direction
- ③ Battery Power
- ④ Speed Setting
- ⑤ Torque Reverse Setting

Torque Display

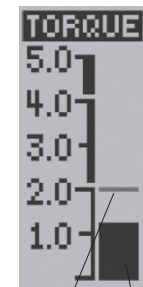

- Current Torque
- Torque Reverse Setting

1. Turn Tri Auto mini on: Press Main switch.

The standby display will appear.

When the standby display is being shown, you can turn the Tri Auto mini off by holding down the Select Switch and pressing the Main Switch

- * The Tri Auto mini turns itself off automatically if it is not used for 3 minutes (factory setting).

2. Select Memory number: Press Plus or Minus switch.

- * There are six memories for various combinations of speed, torque reverse and rotation direction settings.
- * The backlight will temporarily change color if changing the memory number changes anything other than the speed, torque reverse, and rotation direction settings.

3. Start motor: Press Main switch again.

The Torque Display will appear.

- * If you hold the Main Switch down when you start the motor, it will run only while the switch is held down and stop when the switch is released.
- * You can temporarily change the torque reverse setting while the motor is running by pressing the Plus or Minus switch.
- * The color of the backlight changes depending on the load applied to the file.
- * The backlight starts blinking when the load approaches the torque reverse setting.

4. Stop motor: Press Main switch again.

The standby display will reappear.

When connected to the Root ZX mini, refer to page 20 for meter readings and operation.

⚠ WARNING

- Do not fail to check the new settings whenever you change the Memory Number.

⚠ NOTE

- The temperature of the motor handpiece rises up to 47.5°C (117.5°F) when the ambient temperature is 40°C (104°F).

Memory Settings

The factory settings are shown below. These settings can be changed.

Setting	Memory		
	M1, M4	M2, M5	M3, M6
Speed (rpm)	400	400	250
Torque Reverse (Ncm)	1.0	0.8	0.6
Rotation Direction	Forward		
Torque Slow Down	OFF		
Canal Measurement Linkage**	ON		
Apical Reverse or Stop**	Reverse		
Auto Start or Stop**	ON		
Apical Slow Down**	OFF		
Apical Torque Reduction**	OFF		

** These functions are available only when connected to the Root ZX mini.

Memory Settings: Primary Functions

Primary Functions: Rotation Speed, Torque Reverse, Rotation Direction

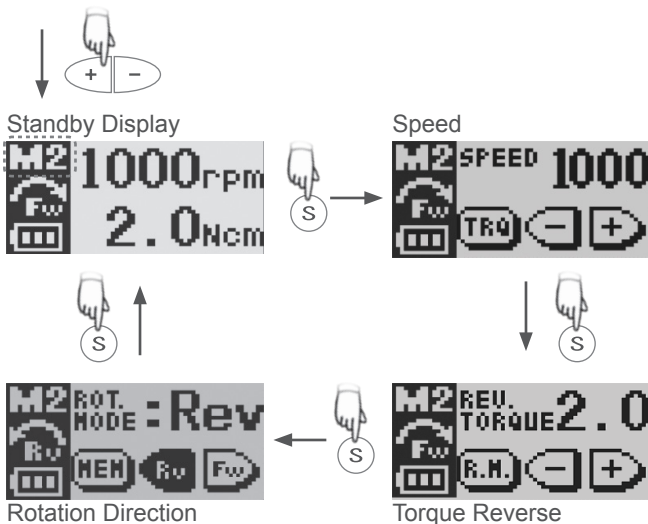

1. Select a memory number for the standby display by pressing the Plus or Minus switch.
2. Press the Select Switch to choose one of the primary functions.
3. Press the Plus or Minus switch to change the setting.

* The display will go back to the standby display if 5 seconds (factory setting) elapses without a switch being pressed.

! Torque reverse values may differ somewhat depending on the motor and contra angle.

Speed Settings:

50, 100, 150, 200, 250, 300, 400, 500, 600, 800 and 1000 rpm

Torque Reverse Settings:

0.2, 0.4, 0.6, 0.8, 1.0, 1.5, 2.0, 2.5 and 3.0 Ncm

This function can also be turned off: TRL (torque reverse-less).

Rotation Direction:

Fwd: Forward, Rev: Reverse

NOTE

- If the torque reverse function is turned off, the file could jam inside the canal and break.
- Torque reverse should be set depending on the canal and the file.
- If the torque reverse seems to be activated too frequently increase its value.

Memory Settings: Additional Operation Settings

Additional Functions: Torque Slow Down (TORQ.SL.D.), Linked to canal measurement (LINKED FUNCTION**), Apical Reverse or Stop (APICAL ACT.**), Auto Start and Stop (AUTO STT/STP**), Apical Slow Down (APICAL SL.D.**), Apical Torque Reduction (APICAL TRQ.D.**)

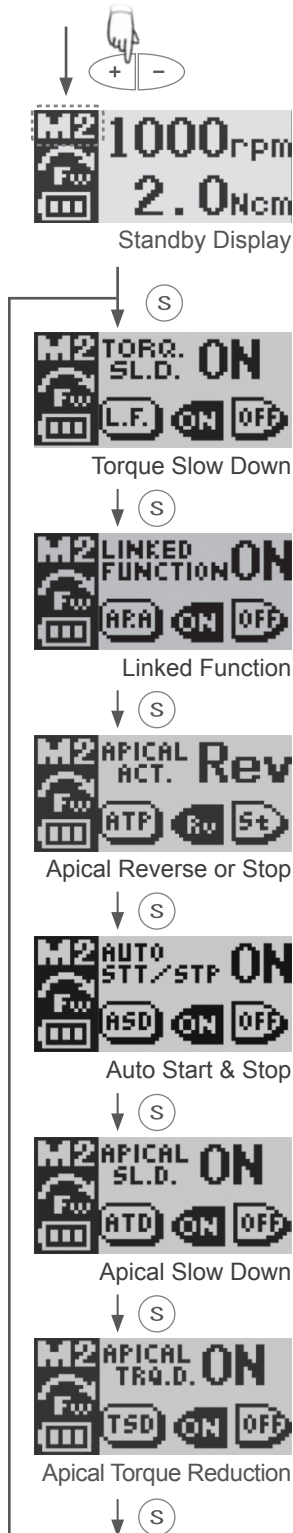

1. Select a memory number for the standby display; press the Plus or Minus switch.
2. Hold down the Select switch for at least 1 second to show the displays for additional operation settings.
3. Press the Select switch to go from one display to the next.
4. Change the setting; press the Plus or Minus switch.

* The display will go back to the standby display if 5 seconds (factory setting) elapses without a switch being pressed.

Torque Slow Down:

When this is turned on, the motor will slow down as the torque load increases.

Linked Function**:

When this is turned on, the functions below will be activated.

Apical Reverse or Stop**:

The file will reverse or stop when the file tip reaches the Flash Bar.

Auto Start & Stop**:

When this is turned on, the file starts rotating when it is inserted and stops when it is taken out of the canal.

Apical Slow Down**:

When this is turned on, the file slows down as it approaches the apex.

Apical Torque Reduction**:

When this is turned on, the torque setting that triggers reverse rotation is reduced as the file tip approaches the apex.

** These functions are available only when connected to the Root ZX mini.

Memory Settings: Other Settings

Other Settings: The factory settings are shown below.

Beeper (BEEP VOLUME)	Big	Right or Left Handed (DOMI. HAND)	Right
Auto Power Off (AUTO PWR)	3 min.	Backlight (B.L.COLOR CHANGE)	ON
Positive/Negative Display (DISP. TYPE)	Posi	Return to Standby Time (S.S.R TIME)	5 sec.

1. With unit turned off, hold down Select Switch and then press the Main Switch.
2. Press the Select Switch to select one of the settings.
3. Press the Plus or Minus switches to change the setting.
4. Press the Main Switch to return to the standby display.

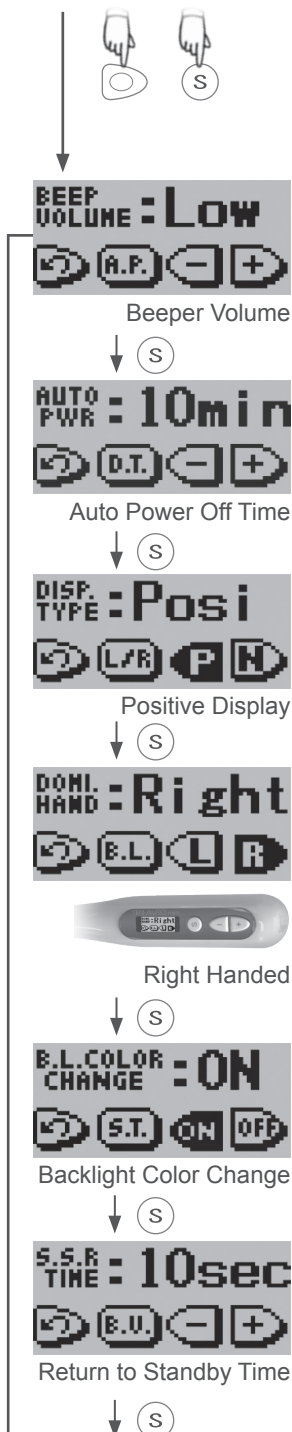

Beeper Volume:

Press Plus or Minus switch to set beep volume used for switch operation and alarms at Off, Low or Big.

Auto Power Off Time:

The time lapse for automatic shut off when the unit is not used can be set from 1 to 15 minutes. Press Plus or Minus switch to set the time.

Positive / Negative Display:

Set display for black on white background or vice versa.

Right or Left Handed:

Set display for right- or left-handed user. Display turns upside down for left-handed users.

Backlight Color Change:

When this is turned on, the backlight will change color depending on torque and file tip location. It also changes color for setting displays. Does not change color when turned off.

Return to Standby Time:

Set the time that elapses before display returns to standby from settings displays. Set from 1 to 15 seconds by pressing Plus or Minus switches.

Restore Default Memories

Restore the original factory settings for the memories in the following way.

* This will restore the original memory settings. You cannot restore settings for just one memory.



1. Hold down the Select Switch, the Plus Switch and the Minus Switch and then turn the unit on with the Main Switch.
2. The "MemClear" display will appear. Press the Select Switch to restore the default memories or press the Main switch to cancel the operation.
3. Wait until the "Finished" display appears and then press the Main switch to go to the standby display.

(3) After Use

Take Out File

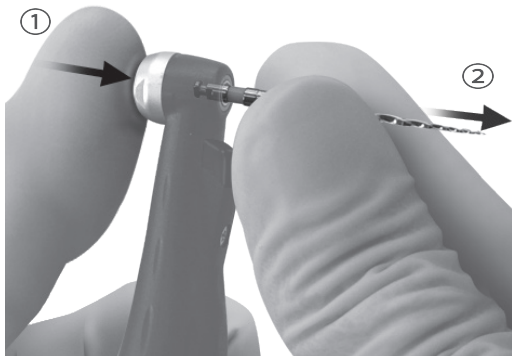

1. Hold down the Select switch and press the Main switch to turn the power off.
* The power will go off automatically if the unit is not used and no switches are pressed for 3 minutes.
2. Hold down the file release button and pull the file straight out.



NOTE

- Take care not to injure your fingers when inserting and removing files.
- Never insert or remove files without holding down the button; this will damage the chuck.
- Make sure the unit is turned off before inserting or removing files.

Usage; Operation with the Root ZX mini

Install File Electrode

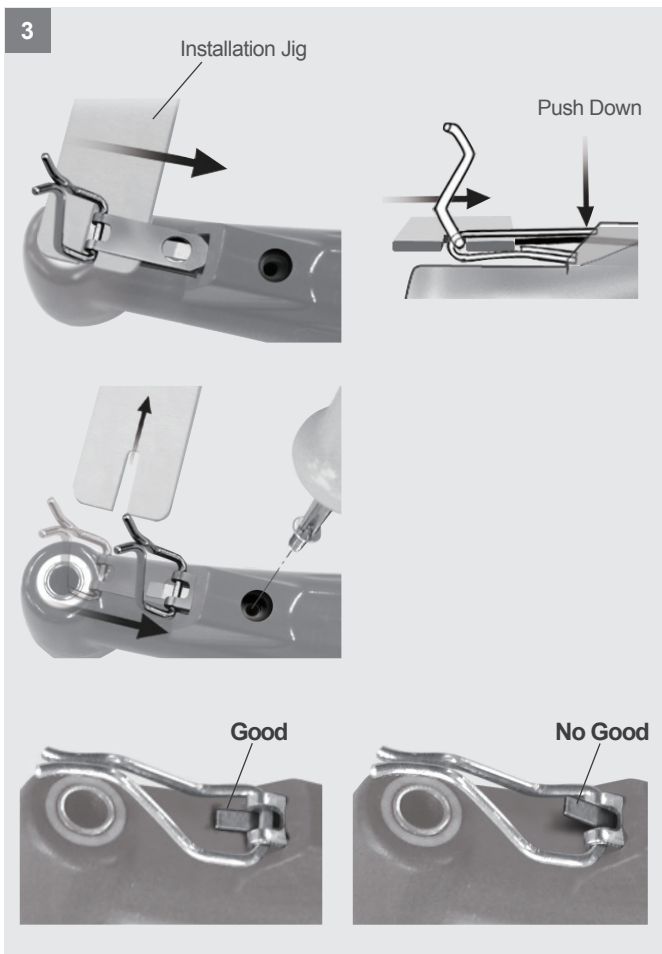
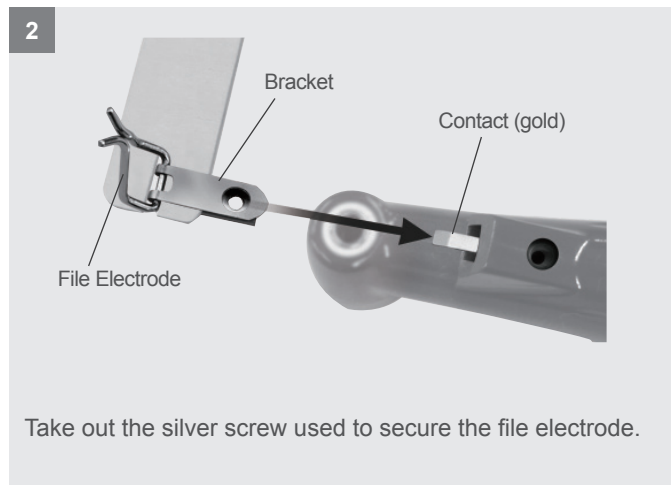
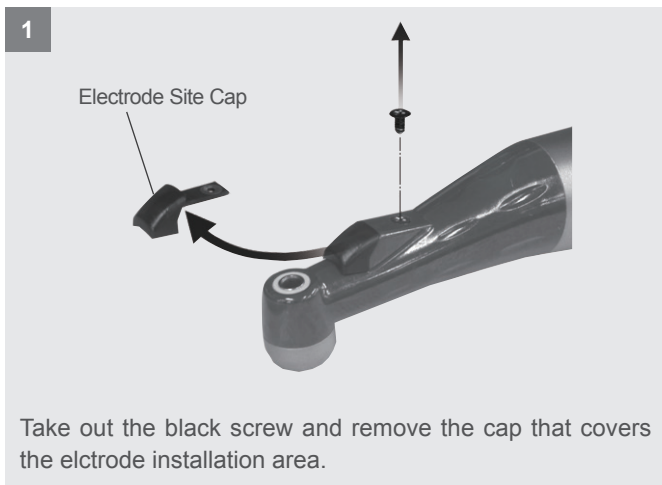

Pick up the installation jig for the electrode with your right hand and then slide the electrode in a little so that the contact on the contra angle goes between the bracket prongs.

* It is easier to get the bracket in if you push the end down slightly.

Pull out the installation jig and push the electrode all the way in. Then secure it with the silver screw. 

* The contact must go between the bracket prongs and then underneath the electrode.

Good: Contact must go under the electrode.

No Good: Contact must not go on top of the electrode.

 Do not mix up the black screw used for the cap and the silver screw used for the electrode.

WARNING

- Make sure the screw is properly tightened up; otherwise it might come out and be swallowed.

Install File Electrode

4

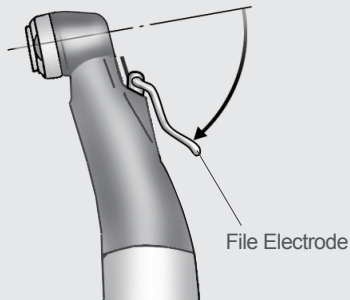

Swing the electrode back as shown in the illustration.

5

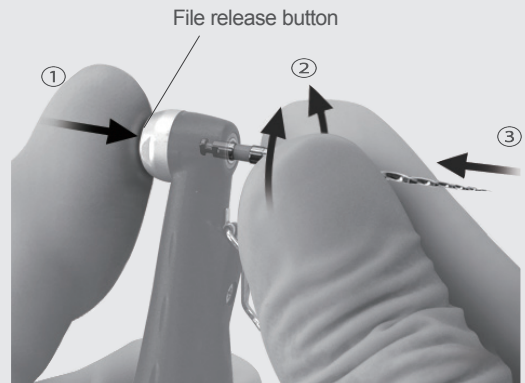

Hold down the file release button.
Insert the file and turn it back and forth until it lines up with the latch mechanism.
Push the file all the way into the latch. Release the file release button.



6

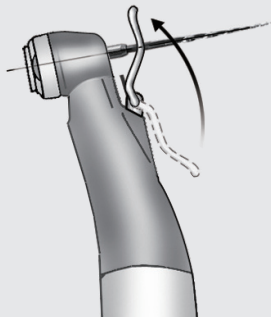

Push the file electrode down so that it pinches the file as shown in the illustration.

- ⚠ Inserting and removing files without holding the file release button down will damage the chuck.
- ⚠ Do not let the electrode pinch the cutting part of the file.
- ⚠ The file electrode may not fit on some types of files.
- ⚠ The file electrode cannot be used for files with a shank diameter greater than 1.2 mm, files with large cutting heads such as largo burrs, files with shanks that are not round and Gates Glidden drills. Do not mix up the black screw used for the cap and the silver screw used for the electrode.

⚠ NOTE

- Use caution when inserting and removing files to avoid injury to fingers.
- Make sure the file goes all the way in. Give the file a light tug to make sure it is properly installed.

Connect the Transmission Cable

* Refer to the user manual for the Root ZX mini.

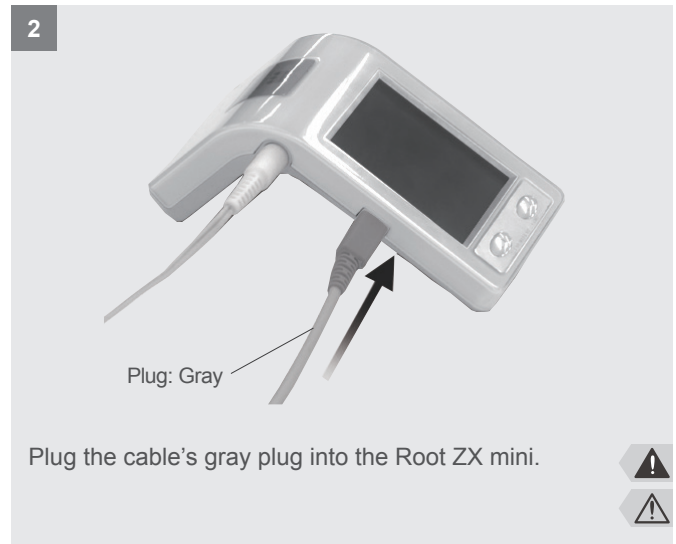
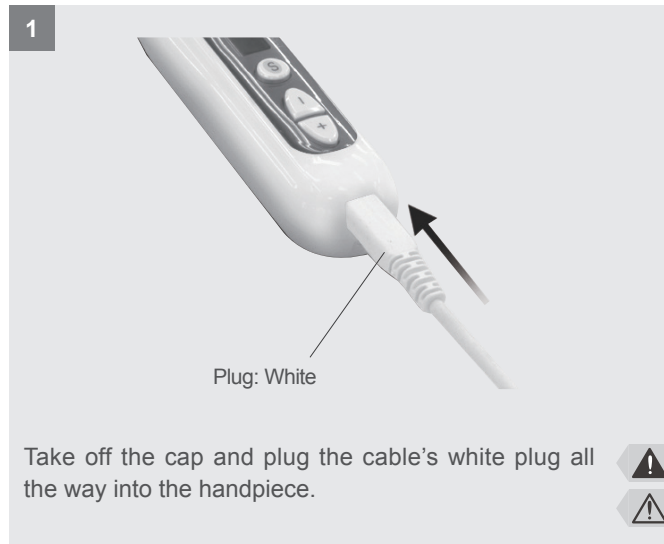

⚠ Do not mix up the cable plugs.

Check Operation

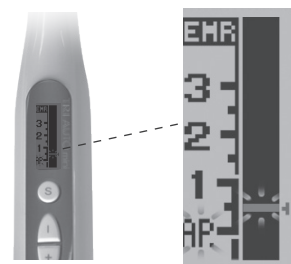
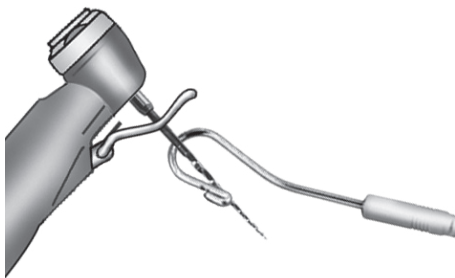

- Make sure file electrode is making good contact with the file.
 - Touch the file with the contrary electrode and make sure the meter goes all the way to its end and there are no segments that do not light up.
- 

⚠ Watch out because the motor might start up when you do this.

⚠ WARNING

- Use only the special cable provided. Other cable could be electrically risky and result in damage or injury. Make sure the file goes all the way in. Give the file a light tug to make sure it is properly installed.
- Check the meter activity before each patient and do not use the instrument if all the segments of the display do not light up. This suggests that the meter cannot make an accurate reading.



⚠ NOTE

- Make sure the plugs go straight in.
- After insertion give plugs a light tug to make sure they are securely connected. Otherwise, data may not be transmitted accurately.
- Do not bump the plugs or drop anything on them when they are plugged in.

Meter Display

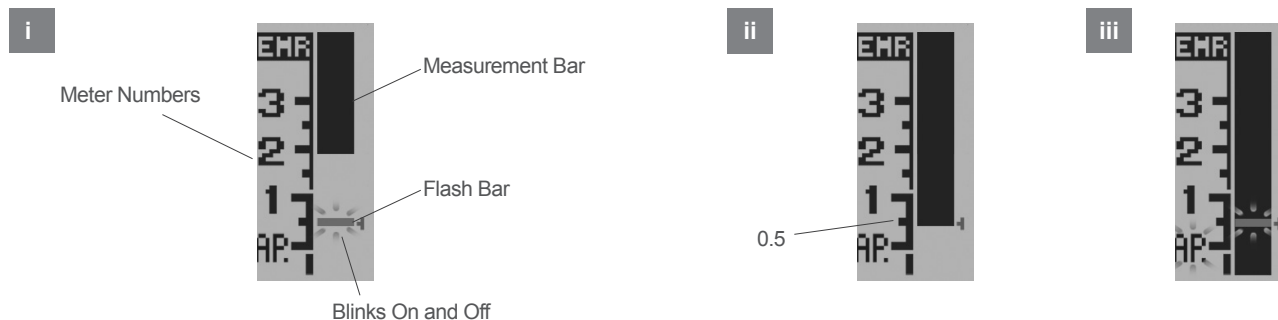
* Refer to the user manual for the Root ZX mini for information about canal measurement and for warnings and notes about use.



- i. The Measurement Bar shows the location of the file tip. The Flash Bar blinks on and off when the file is inside the canal. 
- ii. The 0.5 meter reading shows where the file tip is about 0.5 to 1.0 mm from the anatomical apex. 
 - * The numbers 1, 2, and 3 on the meter do not indicate length in millimeters.
- iii. If the file tip goes past the Flash Bar, an alarm will sound and the backlight will blink on and off.

Operation

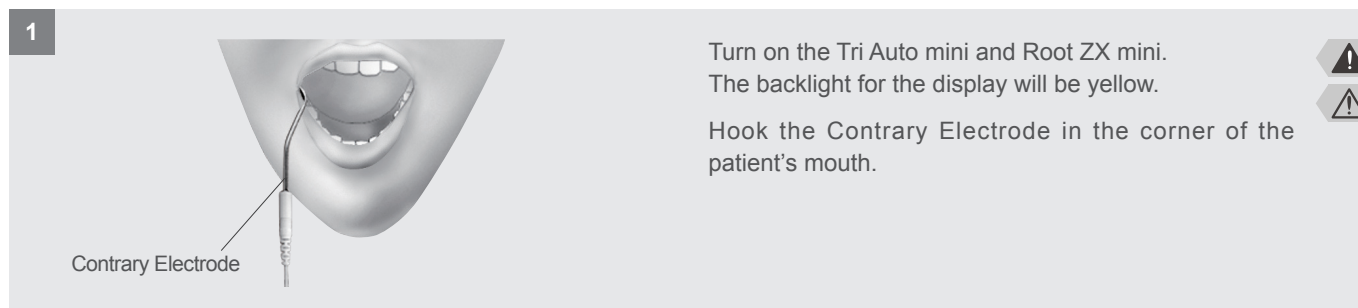

WARNING

- In some cases such as a blocked root canal, a measurement can not be made. (For details refer to the section of the Root ZX mini manual that covers canals not suitable for measurement.)
- Accurate measurement is not always possible, especially in cases of abnormal or unusual root canal morphology; always take an X-ray to check the measurement results.
- If the meter does not move when the file is inserted, the unit may be malfunctioning and must not be used.
- Do not use an ultra sonic scaler while the contrary electrode is hooked in the patient's mouth; noise from the scaler could cause the motor to start running resulting in an accident or injury.
- Absolutely never allow the contrary electrode, the handpiece file electrode or the connections for these to contact an ordinary AC power source such as a socket; this could result in a very serious and dangerous shock.

NOTE

- Occasionally the meter will make a sudden and large movement as soon as the file is inserted into the root canal, but it will return to normal as the file is advanced down towards the apex.
- The contrary electrode, file electrode and metal parts of the contra angle could cause an adverse reaction if the patient has an allergy to metals. Ask the patient about this before using the Tri Auto mini.
- Take care that medicinal solutions such as formalin cresol (FC) or sodium hypochlorite do not get on the contrary electrode or the contra angle. These could cause an adverse reaction such as inflammation.
- The file electrode cannot be used with the following types of files including nickel-titanium ones. Use these files without attaching the file electrode. Files with a shank diameter greater than 1.2 mm, Files with shanks that do not have a circular cross section, Gates Glidden Drills, Tools with large cutting heads such as largo burs.

Operation

2



Select a memory number (M1 to M6) with the Plus or Minus switch.

* Before using motor handpiece, use a small hand file, such as #10 or #15, to penetrate the root canal manually down to the apical constriction.

* The file electrode must be clipped onto the file for accurate measurement and instrument control. (In some cases, a root canal cannot be measured because of an overflow of blood, saliva or chemicals or because the root canal is blocked.)

3

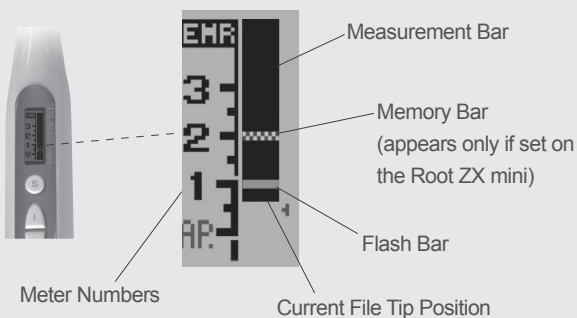

The meter display appears when the file is inserted in to the canal. If the Auto Start and Stop is turned on, the motor will start running too.



* The numbers 1, 2, and 3 on the meter do not indicate length in millimeters but are used to estimate how far the file tip has gone down the canal.

* Press the Select switch to change the display to the Torque display. Press it again to go back to the canal meter display.

The motor will stop when the file tip reaches the point specified by the Flash Bar.

A single sustained beep will sound when this happens. If the unit is set for Apical Reverse, the motor will run backwards after it stops.*

If the load on the file exceeds the setting for torque reverse, the motor will stop and then reverse its rotation.*

A rapid, repeated three-toned beep will sound when this happens.

The motor will stop when the file is taken out of the canal.* Gradually increase the size of the file until the root canal preparation is completed.

If necessary, prepare the apical seat.

(*: Depends on setting.)

ⓘ If the canal is very dry, the Auto Start may not be triggered; in this case, press the Main switch to start the motor.

⚠ WARNING

- Accurate measurements cannot be made in some cases because of shape or other conditions. Always check the measurement with an X-ray.
- Do not let the file or metal parts of the contra angle touch the oral mucosa. This could cause the motor to start running and result in injuring the patient.
- An accurate measurement cannot be made if all the connectors are not properly plugged in. If the meter does not move along with the file, stop using the instrument and check all the connections.

⚠ NOTE

- The meter may not appear if the canal is infected or extremely dry. In this case, put a little hydrogen peroxide or saline solution in the canal but do not let it overflow.

File Electrode Replacement

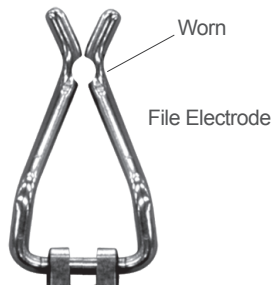

The file electrode wears out and needs to be replaced periodically, about every 6 months or whenever it breaks or is excessively worn. 

* Contact your local dealer or J. MORITA OFFICE to get new file electrodes.

1



Pull the file electrode back. Hold down the file release button and take the file out. Moisten some gauze with ethanol, wring it out and then use it to wipe the contra angle.

Pay special attention to the area where the file electrode is installed and the screw used to fasten it.

2

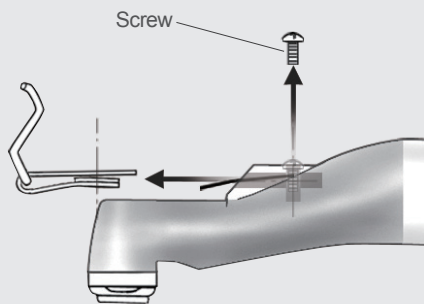

Take out the screw. Take out the old file electrode.

3

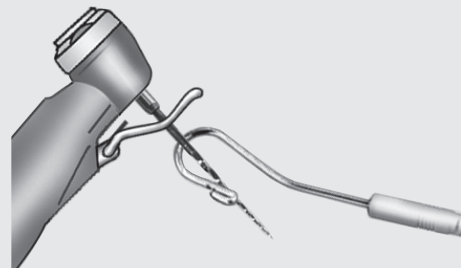

Install the new file electrode.

Make sure the new file electrode makes good contact with the file. Touch the file with the contrary electrode and make sure the meter goes all the way to its end and there are no segments that do not light up. 

* Refer to page 17 for how to install the new file electrode.

 Watch out because the motor might start up when you do this.

WARNING

- Replace the file electrode if it is worn out. Otherwise accurate measurements cannot be made. Also it could break and be swallowed by the patient.
- Make sure the screw is properly tightened up; otherwise it might come out and be swallowed.
- Accurate measurements cannot be made if the file electrode is not properly installed.

NOTE

- Handle the file electrode carefully.

Sterilization, Replacement Parts, and Storage

(1) Sterilization

Autoclaving the Contra Angle



Contra Angle

Autoclave the contra angle after use for each patient.

Recommended: 134°C (273.2°F) for at least 5 minutes inside a sterilization pouch, or 121°C (249.8°F) for at least 35 minutes inside a sterilization pouch.

Minimum drying time after sterilization: 10 minutes.

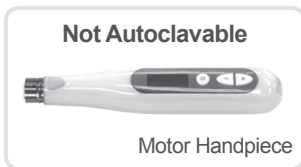

Motor Handpiece

- ⚠ Never autoclave the motor handpiece.
- ⚠ Autoclaving and drying temperatures must never exceed 135°C (275°F).
- ⚠ Take the file out of the contra angle before autoclaving it.
- ⚠ Clean everything thoroughly before autoclaving. Any chemicals or foreign debris left on instruments could cause them to malfunction or could cause discoloration.
- ⚠ For sterilizing files, follow the manufacturer's recommendations.

1



Before autoclaving, lubricate and clean the contra angle.

Place the contra angle in a paper cup with the connection end facing up.



2



Put 10 drops of AR oil on the gear and wait for 10 minutes.



⚠ WARNING

- Do not fail to autoclave the contra angle after use for each patient.

⚠ NOTE

- Do not sterilize in any way other than autoclave.
- The instrument is extremely hot immediately after autoclaving; do not touch it for at least 10 minutes.
- Use only AR Oil for lubrication.
- Leave the contra angle in the paper cup for at least 10 minutes so that the oil is thoroughly absorbed by the contra angle mechanism.

Autoclaving the Contra Angle

3

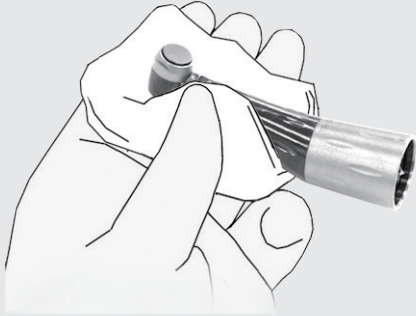

Take the contra angle out of the paper cup and wipe off any excess oil which may have seeped out. Dampen a piece of gauze with ethanol, wring it out and then wipe the contra angle with it. Put the contra angle in a sterilization pouch and autoclave it.

- ⚠ Do not use anything except Ethanol for Disinfection (Ethanol 70 to 80 vol%) for cleaning. Never wipe the contra angle with solutions containing formalin cresol (FC) or sodium hypochlorite, which damage plastic; wipe them off immediately if they accidentally get on the contra angle.
- ⚠ It is highly recommended that instruments be autoclaved in a sterilization pouch (wrapped) or similar device.

Wipe with Ethanol

Components Sterilized with Ethanol : Motor Handpiece, Charger, Power Cord, Transmission Cable

Dampen a piece of gauze with ethanol, wring it out and then wipe these components with it.

- ⚠ Never wipe components with any solution other than Ethanol for Disinfection (Ethanol 70 to 80 vol%). Other solutions could cause cracking and discoloration.
- ⚠ Never wipe components with a piece of gauze that is excessively wet with ethanol. It could seep inside the instrument and damage it. Be especially careful around the connection jacks for the transmission cable.
- ⚠ Avoid spilling chemical solutions used for treatment on the motor handpiece, charger, contra angle or any other components. These chemicals could damage, deform or discolor plastic and metal. Use extra caution to avoid spilling formalin cresol (FC) and sodium hypochlorite as they are quite strong. Wipe up any chemical spills immediately. (Some chemicals may leave traces even if wiped up immediately).

(2) Replacement Parts

* Replace the parts as necessary depending on degree of wear and length of use.

* Order parts from your local dealer or J. MORITA OFFICE.

Battery Replacement

Replace the battery when it starts to lose power relatively quickly after being fully charged.
The battery will last for approximately 1 year under normal circumstances and use.

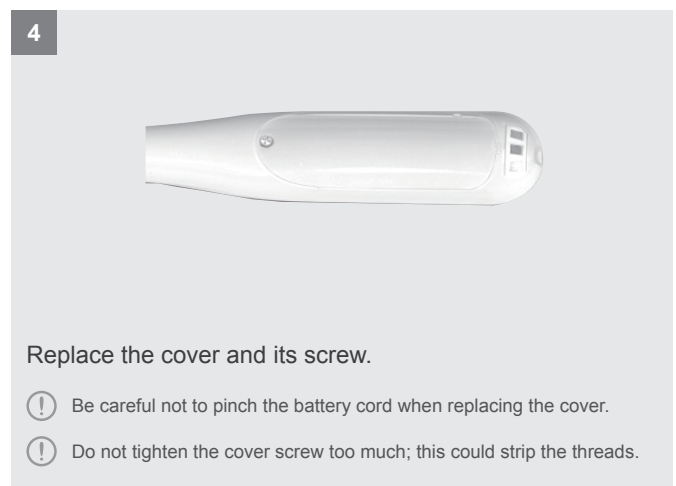
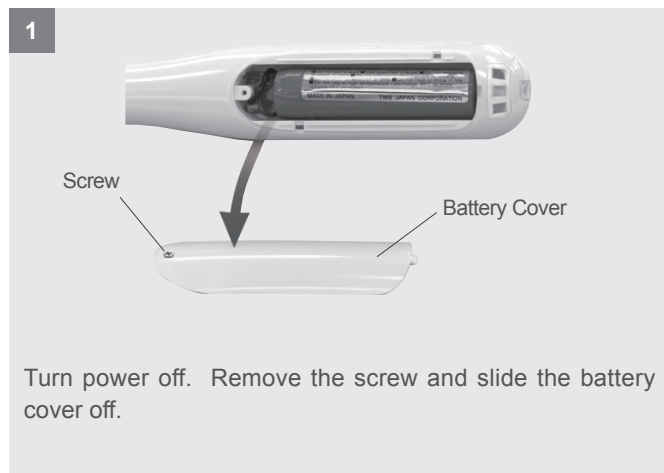

File Electrode Replacement

When connected to the Root ZX mini, refer to page 22 for how to replace the file electrode.

⚠ NOTE

- Use only the battery designed for the Tri Auto mini. Other types could cause overheating.
- Do not use a battery if it is leaky, deformed, discolored or if its label is peeled off. It might overheat.

(3) Storage

Transport and Storage Conditions for the main unit and AC adapter:

Temperature: -10 to 45°C (14 to 113°F), Relative Humidity: 10 to 85 %RH (without condensation),

Atmospheric Pressure: 700 to 1,060 hPa

- * Do not expose to direct sunlight frequently or for long times.
- * If the unit has not been used for a long time, make sure it works properly before using.
- * Always remove the battery prior to storing or shipping the unit.

Maintenance and Inspection

Regular Inspection

- * Maintenance and inspection are generally considered to be the duty and obligation of the user, but if, for some reason, the user is unable to carry out these duties, he may rely on a qualified medical device serviceman. Contact your local dealer or J. MORITA OFFICE for details.
- * Replace the parts listed in the Parts Lists as necessary depending on degree of wear and length of use.
- * This apparatus should be inspected every 6 months in accordance with the following maintenance and inspection items.

Maintenance and Inspection Items

1. Check that the battery does not seem to be losing its charge too quickly.
2. Check that pressing the Main Switch turns the unit on. After the unit is on, check that pressing the Main switch turns the motor on and off. Check that the unit turns off when the Main Switch is pressed while the Select switch is being held down.
3. Check that pressing the Plus and Minus switches changes the memory number from M1 through M6.
4. Check that the settings for each memory can be changed.
5. Make sure the connection end of the motor handpiece is not damaged or dirty.
6. Make sure that the connection end of the contra angle is not damaged or dirty and that it can be securely connected to the motor handpiece. Make sure that the file release button operates properly and that files can be securely installed.
When used with the Root ZX mini, make sure that the file electrode clips securely onto the file and that it is not damaged or worn out.
7. When used with the Root ZX mini, touch the file with the contrary electrode and make sure that all the segments for the meter light up properly.

* For repairs contact your local dealer or J. MORITA OFFICE.

Parts List

Contra Angle
(Code. No. 8450145)



Battery
*Inside motor handpiece
(Code. No. 7505628 [9124055])



Power Supply Cord
(Code. No. 8450110)



Power Supply Cord
(For Australia)
(Code. No. 8450218)



AR Oil
(Code. No. 7503800)



Handpiece Rest
(Code. No. 7503965)

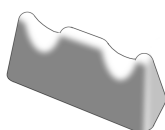

Transmission Cable
(Code. No. 8450129)



File Electrode
(Code. No. 8450137)



■ Working-Life

The working-life of this equipment is 6 years from the date of shipment provided it is regularly and properly inspected and maintained.

■ Disposal of Medical Devices

Any medical devices which could possibly be contaminated must be first decontaminated by the responsible doctor or medical institution and then be disposed by an agent licensed and qualified to handle medical and industrial waste.

The rechargeable battery should be recycled. Metal parts of the equipment are disposed as scrap metal. Synthetic materials, electrical components, and printed circuit boards are disposed as electrical scrap. Material must be disposed according to the relevant national legal regulations. Consult specialized disposal companies for this purpose. Please inquire of the local city/community administrations concerning local disposal companies.

■ Service

Tri Auto mini may be repaired and serviced by

- the technicians of J. MORITA's subsidiaries all over the world.
- technicians employed by authorized J. MORITA dealers and specially trained by J. MORITA.
- independent technicians specially trained and authorized by J. MORITA.

Troubleshooting

If the instrument does not seem to be working properly, the user should first try to inspect and adjust it himself.

* If the user is unable to inspect the instrument himself or if the instrument fails to work properly after being adjusted or after parts are replaced, contact your local dealer or J. MORITA OFFICE.

Problem	Check Points	Response
Does not turn on.	<ul style="list-style-type: none"> • Check battery power. • Check battery installation. 	<ul style="list-style-type: none"> • Charge battery • Install battery properly.
No beeping sound.	<ul style="list-style-type: none"> • Check if sound is turned off. 	<ul style="list-style-type: none"> • Set beep volume for Low or Big
Beep sounds even when unit is not being used.	<ul style="list-style-type: none"> • Unit may be set for reverse rotation. 	<ul style="list-style-type: none"> • A beep sounds periodically whenever the unit is set for reverse rotation. Turn the beeper off if it is annoying. (This will stop all beeping except when the unit is turned on.)
Backlight color does not change.	<ul style="list-style-type: none"> • See if this function has been turned off. 	<ul style="list-style-type: none"> • Turn this function on, if necessary.
Motor does not start when file is inside canal.	<ul style="list-style-type: none"> • Is Root ZX mini properly connected and turned on? • Is the contrary electrode for the Root ZX mini hooked in the patient's mouth? • Is "Linked Function" setting turned off? • Is Auto Start & Stop turned off? • Has the meter gone past the Flash Bar? 	<ul style="list-style-type: none"> • Check transmission cable connections. Turn on Root ZX mini • Hook the contrary electrode in the corner of the patient's mouth. • Turn "Linked Function" setting on. • Turn "Auto Start & Stop" setting on. • Set the Apical Stop or Reverse for Reverse (REV).
Motor starts but then stops right away.	<ul style="list-style-type: none"> • Did you hold down the Main switch for more than 1 second? • Does "Abn.Stop LowBat" appear in the display? 	<ul style="list-style-type: none"> • If you hold the Main switch down for more than 1 second, the motor runs only while the switch is held down and stops when it is released. The motor will run without stopping if you release the switch in less than 1 second. • Very low battery power. Charge battery.
Motor reverses rotation on its own.	<ul style="list-style-type: none"> • Check Torque Reverse setting. • Check Apical Reverse setting. 	<ul style="list-style-type: none"> • The torque reverse can be turned off (TRL setting). • You can change the Apical Reverse setting to Apical Stop.
Motor reverses rotation too quickly.	<ul style="list-style-type: none"> • Check Torque Reverse setting • Is the Apical Torque Reduction setting turned on? 	<ul style="list-style-type: none"> • Increase the torque reverse setting. • The torque reverse value goes down as the file approaches the apex if the Apical Torque Reduction is turned on. Turn this function off to keep the torque reverse value constant.
Motor handpiece will not go in reverse rotation.	<ul style="list-style-type: none"> • Is Torque Reverse setting turned on? • Is Torque Reverse setting too high? • Is "Linked Function" setting turned off? • Is Root ZX mini set for Apical Stop? 	<ul style="list-style-type: none"> • Set torque reverse value • Reduce torque reverse value • Turn "Linked Function" setting on. • Change Apical Stop to Apical Reverse.

Problem	Check Points	Response
Canal measurement display does not appear.	<ul style="list-style-type: none"> • Is the contrary electrode for the Root ZX mini hooked in the patient's mouth? • Did you press the Select switch while the motor was running? • Did a beep sound when you connected the transmission cable? Except for when the beeper is turned off 	<ul style="list-style-type: none"> • Hook the contrary electrode in the corner of the patient's mouth. • Press the Select switch again to display the measurement meter. • If a beep does not sound when you connect the transmission cable, the cable may be defective. Replace it. If this does not solve the problem the connectors or the control board may be defective.
Micromotor changes speed on its own.	<ul style="list-style-type: none"> • Is Apical Slow Down setting tuned on? • Is Torque Slow Down setting tuned on? 	<ul style="list-style-type: none"> • When this is turned on, the motor slows down as the file approaches the apex. Refer to page 14 for how to turn this setting on and off. • When this is turned on, the motor slows down as the torque increases. Refer to page 14 for how to turn this setting on and off.
Unit turns off on its own.	<ul style="list-style-type: none"> • Was the unit no used for a long time? • Does "Please Charge" appear in the display? • This can happen if the battery is very low and a large load is applied to the file. 	<ul style="list-style-type: none"> • Auto power off was probably activated. Press the Main switch to turn the unit back on. • Battery must be charged right away. • Battery must be charged right away.
Error 01	<ul style="list-style-type: none"> • Transmission cable is probably not properly connected. 	<ul style="list-style-type: none"> • Check cable and connect is properly.

Technical Description

Specifications

Name	Tri Auto mini
Model	TR-CM
Classification	Safety according to IEC 60601-1, IEC 60601-1-2, UL 60601-1, CAN/CSA C22.2 No. 601.1-M90, ISO 11498 and ISO 7785-2 European Directive 93/42/EEC IIa Canada Medical devices Class II
Degree of Protection against Electric Shock	Type BF applied part
Degree of Protection (IEC 60529)	IPX O
Mode of Operation	Continuous
Free running speed of the motor handpiece	50 ± 5 to 1000 ± 100 rpm
Rated Torque	min. 0.04 Nm
Motor Handpiece	
Type Classification (Maximum Rotation Speed)	Type 1 (according to ISO 11498)
Rated Motor Input Voltage	DC 3.7 V
Dimension	max. diameter 28 ± 3 (mm) × length 150 ± 10 (mm)
Weight	Approximately 80 g
Motor	Miniature Direct Current Motor
Coupling Identification	TR-CM coupling It can be used with only TR-CM contra angle.
Mode of Operation	Continuous
Field Repair	It can not be repaired in the field. Send to J. MORITA regional office or local dealer for repair.
Contra Angle	
Model	TR-CM contra angle
Free Running Maximum Operation Speed	1000 rpm
Minimum Fitting Length of Shank	9.0 mm
Maximum Overall Length of Rotary Instrument	28.0 mm
Type of Shank	Type 1 (according to ISO 1797-1)
Type of Coupling	TR-CM coupling * It can be used only with TR-CM motor handpiece.
Gear Ratio	1.88 : 1
Chuck Type	Push Button Latch
Charger	
Rated Input voltage	A.C.100–240 V
Frequency	50/60 Hz
Power Consumption	5 W
Output	3.5 VA

[Specifications may be changed without notice due to improvements.]

Symbols

Labels



CE(0197)marking
Conforms with the European Directive, 93/42/EEC.

CE marking
Conforms with the European Directive, 2011/65/EU.



Attention, consult accompanying documents.



Manufacturer



Type BF applied part (Contrary Electrode and File Holder)



Serial Number



Class II Equipment

Example)

SN D A 00001



① Year of Manufacture
D: 2015, E: 2016, F: 2017...

② Month of Manufacture
A: Jan., B: Feb., C: March...

③ Lot No.
00001, 00002, 00003...



This symbol is affixed to fulfill the requirements of EU Directive 2002/92/ED Article 11. This equipment cannot be disposed of as unsorted municipal waste within the European Union. Follow local regulations for disposal.



Autoclavable up to 135°C (275°F)

Operation Instructions



Authorised representative in the European Community



CE(0197)marking
Conforms with the European Directive, 93/42/EEC.



Manufacturer

CE marking
Conforms with the European Directive, 93/42/EEC.

Package



TEMPERATURE LIMITATION



KEEP DRY



Attention, consult accompanying documents.



FRAGILE



THIS WAY UP

Appendix- Electromagnetic declaration

Guidance and manufacturer's declaration – electromagnetic emissions		
The TR-CM is intended for use in the electromagnetic environment specified below. The customer or the user of the TR-CM should assure that it is used in such an environment.		
Emissions test	Compliance	Electromagnetic environment - guidance
RF emissions CISPR 11	Group 1	The TR-CM uses RF energy only for its internal function. Therefore, its RF emissions are very low and are not likely to cause any interference in nearby electronic equipment.
RF emissions CISPR 11	Class B	The TR-CM is suitable for use in all establishments, including domestic establishments and those directly connected to the public low-voltage power supply network that supplies buildings used for domestic purposes.
Harmonic emissions ^{*1} IEC61000-3-2	Class A	
Voltage fluctuations/ flicker emissions ^{*1} IEC 61000-3-3	Complies	

*1: Charger Data

Guidance and manufacturer's declaration – electromagnetic immunity			
The TR-CM is intended for use in the electromagnetic environment specified below. The customer or the user of the TR-CM should assure that it is used in such an environment.			
Immunity test	IEC 60601 test level	Compliance level	Electromagnetic environment - guidance
Electrostatic discharge (ESD) IEC 61000-4-2	+6 kV contact +8 kV air	+2, 4, 6 kV contact +2, 4, 8 kV air	Floors should be wood, concrete or ceramic tile. If floors are covered with synthetic material, the relative humidity should be at least 30 %.
Electrical fast transients/ bursts IEC 61000-4-4	+2 kV for power supply lines +1 kV for input/ output lines	+2.0 kV for power supply lines ^{*2}	Mains power quality should be that of a typical commercial or hospital environment.
Surge IEC 61000-4-5	+1 kV line(s) to line(s) +2 kV line(s) to earth	+0.5, 1, 2 kV line(s) to line(s) +0.5, 1 kV line(s) to earth	Mains power quality should be that of a typical commercial or hospital environment.
Voltage dips, short interruptions and voltage variations on power supply lines IEC 61000-4-11	<5% UT (>95% dip in UT) for 0.5 cycle 40% UT (60% dip in UT) for 5 cycles 70% UT (30% dip in UT) for 25 cycles <5% UT (>95% dip in UT) for 5 sec	0% UT (>95% dip in UT) /0.5 periods 40% UT (60% dip in UT) /5 periods 70% UT (30% dip in UT) /25 periods 0% UT /5 sec.	Mains power quality should be that of a typical commercial or hospital environment. If user of the TR-CM requires continued operation during power mains interruptions, it is recommended that the TR-CM be powered from an uninterruptible power supply or a battery.
Power frequency (50/60 Hz) magnetic field IEC 61000-4-8	3 A/m	3.15 A/m	Power frequency magnetic field should be at levels characteristic of a typical location in a typical commercial or hospital environment.
Note: UT is the a.c. mains voltage prior to application of the test level.			

*2: This test is not applicable since the EUT signal cable is less than 3 m.

Guidance and manufacturer's declaration – electromagnetic immunity

The TR-CM is intended for use in the electromagnetic environment specified below. The customer or the user of the TR-CM should assure that it is used in such an environment.

Immunity test	IEC 60601 test level	Compliance level	Electromagnetic environment - guidance
<p>Conducted RF IEC 61000-4-6</p> <p>Radiated RF IEC 61000-4-3</p>	<p>3 Vrms 150 kHz to 80 MHz</p> <p>3 V/m 80 MHz to 2.5 GHz</p>	<p>3.15 V</p> <p>3.5 V/m</p>	<p>Portable and mobile RF communications equipment should be used no closer to any part of the TR-CM, including cables, than the recommended separation distance calculated from the equation applicable to the frequency of the transmitter. Recommended separation distance</p> <p>$d = 1.11 \sqrt{P}$ 80 MHz to 800 MHz $d = 2 \sqrt{P}$ 800 MHz to 2.5 GHz</p> <p>Where P is the maximum output power rating of the transmitter in watts (W) according to the transmitter manufacturer and d is the recommended separation distance in meters (m).</p> <p>Field strengths from fixed RF transmitters, as determined by an electromagnetic site survey, a should be less than the compliance level in each frequency range. b</p> <p>Interference may occur in the vicinity of equipment marked with the following symbol:</p> 

NOTE 1: At 80 MHz and 800 MHz, the higher frequency range applies.

NOTE 2: These guidelines may not apply in all situations. Electromagnetic propagation is affected by absorption and reflection from structures, objects and people. Power frequency magnetic field should be at levels characteristic of a typical location in a typical commercial or hospital environment.

- a Field strengths from fixed transmitters, such as base stations for radio (cellular/cordless) telephones and land mobile radios, amateur radio, AM and FM radio broadcast and TV broadcast cannot be predicted theoretically with accuracy. To assess the electromagnetic environment due to fixed RF transmitters, an electromagnetic site survey should be considered. If the measured field strength in the location in which the TR-CM is used exceeds the applicable RF compliance level above, the TR-CM should be observed to verify normal operation. If abnormal performance is observed, additional measures may be necessary, such as reorienting or relocating the TR-CM.
- b Over the frequency range 150 kHz to 80MHz, field strengths should be less than 3 V/m.

Recommended separation distances between portable and mobile RF communications equipment and the TR-CM.

The TR-CM is intended for use in an electromagnetic environment in which radiated RF disturbances are controlled. The customer or the user of the TR-CM can help prevent electromagnetic interference by maintaining a minimum distance between portable and mobile RF communications equipment (transmitters) and the TR-CM as recommended below, according to the maximum output power of the communications equipment.

Rated maximum output power of transmitter (W)	Separation distance according to frequency of transmitter (m)		
	150 kHz to 80 MHz $d = 1.11 \sqrt{P}$	80 MHz to 800 MHz $d = \sqrt{P}$	800 MHz to 2.5 GHz $d = 2 \sqrt{P}$
0.01	0.11	0.1	0.2
0.1	0.35	0.32	0.63
1	1.11	1	2
10	3.51	3.16	6.32
100	11.11	10	20

For transmitters rated at a maximum output power not listed above, the recommended separation distance d in meters (m) can be estimated using the equation applicable to the frequency of the transmitter, where P is the maximum output power rating of the transmitter in watts (W) according to the transmitter manufacturer.

NOTE 1: At 80 MHz and 800 MHz, the separation distance for the higher frequency range applies.

NOTE 2: These guidelines may not apply in all situations. Electromagnetic propagation is affected by absorption and reflection from structures, objects and people.

Essential Performance:

Noise does not substantially change measurement.

Noise will not change operation mode.

Noise will not permanently alter display values.

Accessories:

Transmission Cable
(Length : 1.5 meters)



⚠ WARNING

- Use of the parts other than those accompanied or specified by J. MORITA MFG. CORP. may result in increased EMC emissions or decreased EMC immunity of the TR-CM.

Safety and Accident Prevention for the Operation of Electrical Medical Devices

1. Only fully trained and qualified personnel may operate equipment.
2. Items to be duly noted when installing equipment.
 - 1) Locate the unit in a place where it will not get wet.
 - 2) Install the unit in a location where it will not be damaged by air pressure, temperature, humidity, direct sunlight, dust, salts, or sulfur compounds.
 - 3) The unit should not be subjected to tilting, excessive vibrations, or shocks (including during shipping and handling).
 - 4) Do not install the unit where chemicals are stored or where gas may be released.
 - 5) Follow all electrical specifications including frequency (Hz), voltage (V), and current capacity (A) (power consumption).
 - 6) The equipment must be properly grounded.
3. Item to be duly noted before use.
 - 1) Inspect all switch connections, polarity, dial settings, meters etc. to confirm that the equipment will operate properly.
 - 2) Confirm that the ground is connected properly.
 - 3) Confirm that all cords are connected properly.
 - 4) Take into consideration that simultaneous use of more than one instrument or device can create a dangerous situation or lead to a mistake in diagnosis.
 - 5) Reconfirm the safety of external circuits or systems which are connected directly to the patient.
4. Item to be duly noted during use.
 - 1) Never use the equipment for treatment or diagnosis more than necessary or for longer than necessary.
 - 2) Maintain a constant vigilance for abnormal conditions in both the equipment and the patient.
 - 3) Appropriate steps, such as shutting the equipment down, should be devised to protect the safety of the patient in case any abnormalities in the equipment or the patient are observed.
 - 4) Make sure the patient does not handle or manipulate the equipment.
5. Item to be duly noted after use.
 - 1) Turn the power off after returning dials, switches etc. back to their original positions in the prescribed order.
 - 2) Do not use excessive force or pull the cord itself to disconnect cords.
 - 3) The following items should be considered when storing the equipment:
 - (1) The storage area should protect the equipment from getting wet.
 - (2) The storage area should protect the equipment from any possible damage due to atmospheric pressure, temperature, humidity, wind, direct sunlight, dust or air containing salts or sulfur.
 - (3) The equipment should be protected from tilting, vibrations, percussive shocks, etc. (including when it is being moved).
 - (4) The storage area should be free of chemicals and gases.
 - 4) All accessories, cords, guides etc. should be cleaned, properly arranged and carefully put away.
 - 5) Before storage, the equipment should be cleaned so that it is ready to be used again.
6. In case of a malfunction or defect, the operator should attach a written notice indicating that the equipment is out of order without attempting to repair the equipment himself; repairs should be referred to a qualified serviceman.
7. Equipment should not be modified in any way.
8. Maintenance and Inspection
 - 1) All equipment and components should be inspected regularly.
 - 2) Equipment which has not been used recently should always be inspected to confirm that it functions properly and safely before being put back into use.

Development and Manufacturing

J. MORITA MFG. CORP.

680 Higashihama Minami-cho, Fushimi-ku, Kyoto 612-8533, Japan
T +81. (0)75. 611 2141, F +81. (0)75. 622 4595

Morita Global Website www.morita.com

Distribution

J. Morita Corporation

3-33-18 Tarumi-cho, Suita-shi, Osaka 564-8650, Japan
T +81. (0)6. 6380 1521, F +81. (0)6. 6380 0585

J. Morita USA, Inc.

9 Mason, Irvine CA 92618, USA
T +1. 949. 581 9600, F +1. 949. 581 8811

J. Morita Europe GmbH

Justus-von-Liebig-Strasse 27a, 63128 Dietzenbach, Germany
T +49. (0)6074. 836 0, F +49. (0)6074. 836 299

Morita Dental Asia Pte. Ltd.

3 Science Park Drive,
#01-05 The Franklin Singapore Science Park1, Singapore 118223
T +65. 6779. 4795, F +65. 6777. 2279

J. Morita Corporation Australia & New Zealand

Suite 2.05, 247 Coward Street, Mascot NSW 2020, Australia
T +61. (0)2. 9667 3555, F +61. (0)2. 9667 3577

J. Morita Corporation Middle East

4 Tag Al Roasaa, Apartment 902, Saba Pacha 21311 Alexandria, Egypt
T +20. (0)3. 58 222 94, F +20. (0)3. 58 222 96

J. Morita Corporation India

Filix Office No.908, L.B.S. Marg, Opp. Asian Paints,
Bhandup (West), Mumbai 400078, India
T +91-22-2595-3482

J. MORITA MFG. CORP. Indonesia Representative Office

28F, DBS Bank Tower, Jl. Prof. Dr. Satrio Kav. 3-5, Jakarta 12940, Indonesia
T +62-21-2988-8332, F + 62-21-2988-8201

Siamdent Co., Ltd.

71/10 Mu 5, Thakham, Bangpakong, Chachuengsao 24130, Thailand
T +66. 38. 573042, F +66. 38. 573043 www.siamdent.com

EU Authorized Representative under the European Directive 93/42/EEC



MEDICAL TECHNOLOGY PROMEDT CONSULTING GmbH

Altenhofstraße 80, 66386 St. Ingbert, Germany T +49. 6894 581020, F +49. 6894 581021

The authority granted to the authorized representative, MEDICAL TECHNOLOGY PROMEDT Consulting GmbH, by J. MORITA MFG. CORP. is solely limited to the work of the authorized representative with the requirements of the European Directive 93/42/EEC for product registration and incident report.